



USERS MANUAL FOR PROGRAMMING THE SENSO MOTOR

ATTENTION !!!



We would like to inform you about the absolute prohibition of screwing into the product's carrier. Blocking the ERS actuator by screwing it to the roller tube will cause that the SENSO obstacle detection function will not work. The length of the driver has been chosen so that screwing is not required.

MOBILUS MOTOR Spółka z o.o.
ul. Miętowa 37, 61-680 Poznań, PL
tel. +48 61 825 81 11, fax +48 61 825 80 52
VAT NO. PL9721078008

www.mobilus.pl

CONTINUED SHORT PROGRAMMING INSTRUCTION ERS TUBULAR MOTOR

5 LOWER END POSITION.
Using the buttons of the remote control DOWN, UP, STOP, set the shutter armor to the desired DOWN limit position **a** (height which the shutter will stop when lowering). The selected position is confirmed by holding the STOP button on the remote control until the tubular motor will make two micro movements. LOWER END POSITION is set.

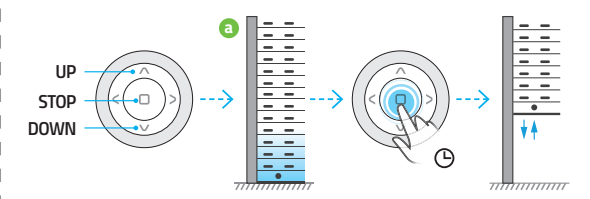

6 UPPER END POSITION.
Set the shutter armor to the desired UPPER end position **a** (height which the shutter will stop when lifting). The selected position is confirmed by holding the STOP button on the remote control until the tubular motor will make two micro movements. UPPER END POSITION is set.

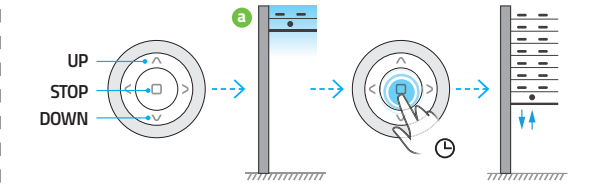

7 RESET OF THE TUBULAR MOTOR.
To reset the tubular motor to FACTORY SETTINGS, press and hold the button in the tubular motor head. At the moment when it turns green, let go of the button - the tubular motor will make a noticeable, audible one sequence of micro movements down / up. Then press and hold the button again until the tubular motor makes a noticeable, audible two sequences of micro movements down / up and the diode in the tubular motor button stop blinking.

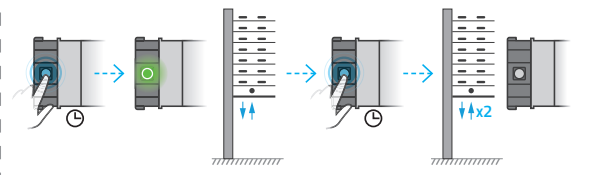

ENVIRONMENTAL PROTECTION

This appliance is marked according to the European Directive on Waste Electrical and Electronic Equipment (2002/96/EC) and further amendments. By ensuring this product is disposed of correctly, you will help to prevent potential negative consequences for the environment and human health, which could otherwise be caused by inappropriate waste handling of this product. The symbol on the product, or the documents accompanying the product, indicates that this appliance may not be treated as household waste. It shall be handed over to the applicable collection point for the waste electrical and electronic equipment for recycling purpose. For more information about recycling of this product, please contact your local authorities, your household waste disposal service or the shop where you purchased the product.

SHORT PROGRAMMING INSTRUCTION ERS TUBULAR MOTOR

1 CONNECT THE ERS TUBULAR MOTOR TO THE POWER SUPPLY.
The power scheme is shown in item 15.

2 ENTER THE MOBILUS ERS TUBULAR MOTOR INTO PROGRAMMING MODE.
Press and hold the button in the tubular motor head. At the moment when it turns green, let go of the button - the tubular motor will make a noticeable, audible one sequence of micro movements down / up. PROGRAMMING MODE is active for 20 seconds.

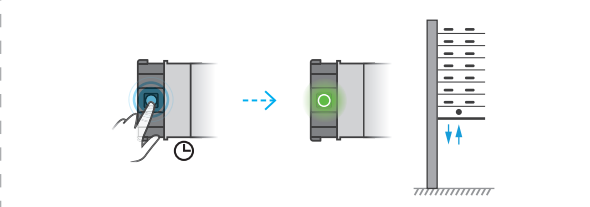

3 LOAD COSMO SERIES REMOTE TO MOBILUS ERS TUBULAR MOTOR.
On the MASTER remote control, simultaneously press and hold the STOP and UP buttons until the green LED in the head of the tubular motor stop blink (the tubular motor will simultaneously make a noticeable, audible one sequence of micro movements down / up). The remote control has been loaded. Check the correctness of the control directions of lifting and lowering the armor from the remote control.

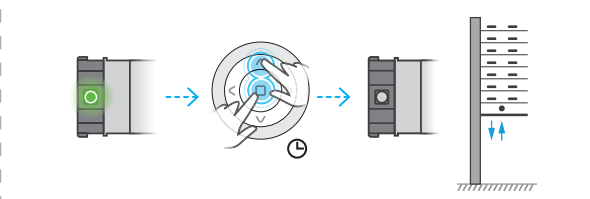

*How to change the direction of rotation of the tubular motor?
If you press the UP button on the remote control and the armor moves DOWN, change the direction of rotation of the tubular motor: simultaneously press and hold the buttons: on the COSMO remote control | HT, | H24, | H1, | H5, | G, | W1, | W7, | L1, | L5 DOWN and UP buttons; on the COSMO remote control COSMO | HCT UP and F3 buttons; on the COSMO remote control COSIMO | HIM, | HB, | G3+, | WT9, | WT DOWN and STOP buttons - until the tubular motor performs one micro-down / up sequence. Check the operation of the UP / DOWN buttons. Change of the directions can only be made before the end positions are set.*

4 SETTING UP OF THE LIMIT SWITCHES.
Using the remote control, set the shutter at a height of approx. 40 cm above the window sill, floor, etc. Then hold the button in the head of the tubular motor until the operator makes a visible movement of lowering / lifting the shutter - the LED in the button will flash green.

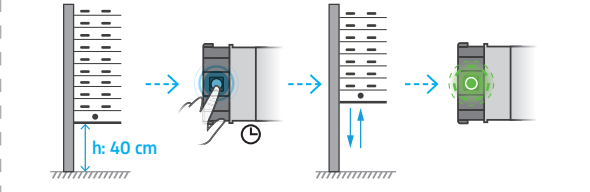

15. CHANGING THE WIRED CONTROL MODE

It is possible to switch the CONTROL MODE of the ERS tubular motor:
- without support (factory set) - short pulse control;
- with support - operation of the tubular motor depends on the length of the signal being given;

1. Enter the tubular motor in the PROGRAMMING MODE: turn off and turn on the ERS tubular motor twice - Fig. 15.1. The drive will make a noticeable, audible single sequence of micro movements down / up, the LED in the button will turn green.

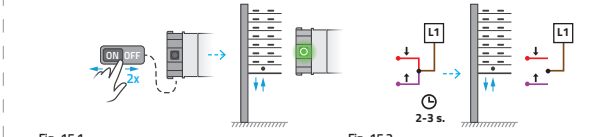

2. Then, after about 2-3 seconds, connect the directional wires - violet and red with phase conductor (Fig. 15.2) until the tubular motor makes a noticeable, audible single micro-down / up sequence. **WARNING!! Remember: disconnect the connected purple, red and phase wires.** The tubular motor will switch the CONTROL MODE and exit the PROGRAMMING MODE.

3. Return to the previous WIRED CONTROL MODE - perform operations from step 1 and 2 again.

16. POWER SUPPLY SCHEME

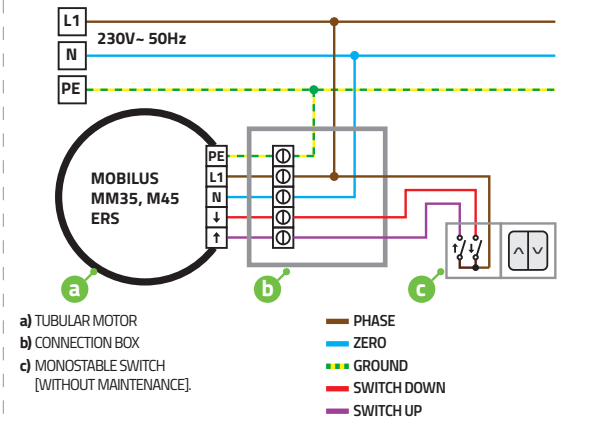

17. WARNINGS

- Approaching to the moving curtain is not allowed till it is completely closed.
- Special caution must be taken by manual emergency service because the open curtain can suddenly fall down due to the weak or broken hangers.
- Switching on the awnings is not allowed if near around takes place the maintenance of the building (e.x. washing the windows).
- Disconnecting of the tubular motor's supply of the automatic awning is demanded if near around takes place the maintenance of the building (e.x. washing the windows).
- The minimum horizontal distance of 0,4 m between completely unrolled awning and any object is demanded.
- WARNING!!!** The use of long control cables, run in parallel with the power supply cables, may result in incorrect operation of the actuators due to the induction of voltage in the control lines. If you use control cables longer than those used in the factory, please contact the technical department of Mobilus Motor Sp. z o.o.

The technical data of the tubular motor are given on its data plate.
The minimal pipe diameter in which the installation of the tubular motor is possible is 40 mm.

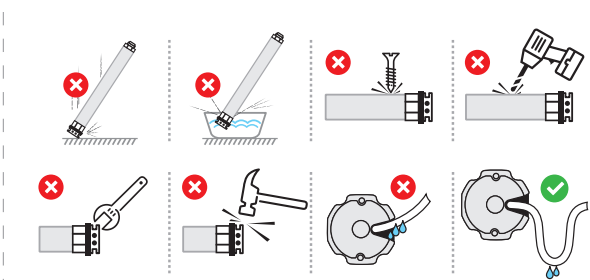

11. RESET OF THE TUBULAR MOTOR – RESTORE PRESETS

ATTENTION!!! Restoring of presets is deleting from the Senso memory all learned transmitters and all registered limit switches.

- Put the Senso tubular motor into Master transmitter programming mode – two ways:
a) Press the programming button on the Senso motor for about 5 seconds - Fig. 11.1a.
b) Switch on and off twice the motor's power supply - Fig. 11.1b.

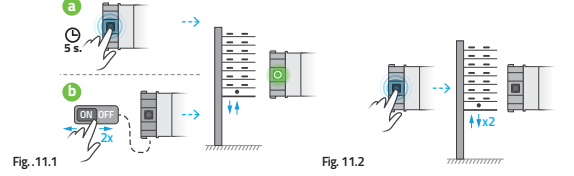

- Press and hold the programming button in the Senso motor for about 5 seconds until it makes some UP/ DOWN moves. It means that reset of the Senso motor was successfully completed and the motor is ready to learn the transmitter – green diode is blinking with the continuous light - Fig. 11.2.

12. OBSTACLE DETECTION SWITCHING ON/OFF FUNCTION

There is a possibility of switching off the obstacle detection (the tubular motor will be working in the manual mode).

- Press and hold the STOP and UP buttons on the Master transmitter for about 5 seconds. The Senso tubular motor will enter the programming mode, make UP/DOWN motions, diode in the button will blink with the green light - Fig. 12.1a.
- Press and hold the STOP button for about 10 seconds. The Senso motor will switch on/off the obstacle detection, make UP/ DOWN motion and leave the programming mode. - Fig. 12.1b.

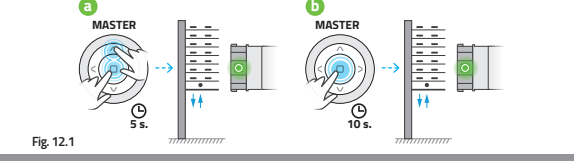

13. COMFORT FUNCTION

PROGRAMMING OF THE COMFORT POSITION:

- Put the roller in position that should be registered as comfort position.
- In the working mode on Senso motor press the STOP button on the Master transmitter for about 15 seconds. The Senso tubular motor will register the comfort position and make an UP/DOWN motion.

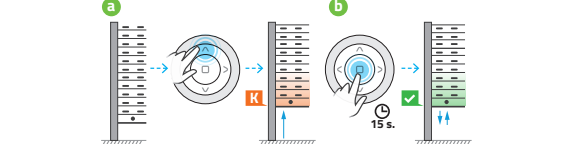

ACTIVATING OF THE COMFORT POSITION

Press the STOP button on the transmitter for about 3 seconds by not working Senso tubular motor. The roller will take an earlier programmed comfort position.



14. BI-DIRECTIONAL COMMUNICATION, SIGNAL REPEATER FUNCTION

Tubular motors with a built-in radio system also have the following functionality:
BI-DIRECTIONAL COMMUNICATION - allows the exchange of information between the tubular motor and the remote control. Depending on the model of the radio controller, the user may obtain more or less extensive messages (location of the shutter, encounter of obstacles, etc.). Bi-directional communication is enabled at the factory and does not require any action on the part of the user.
SIGNAL REPEATER - this function makes it possible to extend the range of radio control. The tubular motor with the repeater function enabled receives signals from the controller or tubular motor and transmits them further by amplifying it. Thanks to this, the farthest located receivers, not being in the range of the controller, can receive and transmit information via indirectly actuated tubular motors. Enabling the function:

- Enter the tubular motor in the PROGRAMMING MODE.
- On the remote control, press the sequence of buttons: UP, STOP, DOWN, UP, STOP, DOWN.

Activation of the repeater function will result in three sequences of micro movements by the tubular motor. Deactivation of the repeater function will result in 2 micro movements by the tubular motor.

WARNING!!! The signal repeater function should be turned on only in devices that are on the limit of signal range. Due to the effective work, we recommend turning on the signal repeater function in up to three devices in the facility. Unjustified activation of the signal repeater function in many devices may cause interference in all radio devices.

1. SENSO – TECHNICAL CONDITIONS OF INSTALLING THE TUBULAR MOTORS

The proper functioning of Senso Motor depends on manufacturing the roller and its correct installation. The shutter should move smoothly, without any obstacles along the slides. Pay careful attention to:

- The vertical fitting of the slides,
- Smooth work of the shaft bearing,
- Deflection of the shaft (of the roll tube) caused by exceeding the width or weight of the shutter,
- The high quality of shutter, especially of profile's work in locks – shutter's beam cannot rub against the box or its elements, e.x. thermal insulation (polystyrene) in the top-mounted roller shutters,
- Using of high quality coat hangers which do not become deformed while using the roller.

Using of the MM 35 motors requires fulfilling the additional conditions. This is a consequence of using the 40 mm octagonal roll tubes in which between roller-tube and the motor's housing there is a small space. There are some instructions that should be followed:

- Pipe's seam cannot rub against motor's housing,
- We recommend using pipes with the outer seam,
- Motor's position in the octagonal roll tube should enable the hanger's installation in the largest space between pipe and motor's housing
- The most safest is the hanger with the low catch.

Shutter assembled not according to the good roller's installation practice that doesn't show any tendency to going down /rolling can be the cause of disturbance of the obstacle detection system in the Senso tubular motor.

Pay careful attention to: Ovalization of the shutter's beam. Situation when the shutter's oval is located directly over the slide's intakes is the most optimal option for correct work of the tubular motor. The negative factor can be eliminated by using proper rings making the diameter bigger or by ballasting the endslat.

The Senso tubular motor enables setting the end limit switches in the automatic mode – using the buffers is required. In this case, following issues have to be taken into consideration:

- The most profitable is using of the inside buffers installed in the down endslat,
- In case of using the outer buffers that are installed in the down endslat, they should be located on the right side of shutter. The point-intake designed for screwing should be located in the distance not larger than 100 mm from the shutter's edge.

The MOBILUS ERS tubular motor should be powered only from the power grid meeting the relevant standards. It is forbidden to connect the MOBILUS ERS tubular motor to any type of aggregates / generators.

2. PROGRAMMING OF THE MASTER REMOTE CONTROL

1. Please bring the Senso motor in the programming mode – there are 3 possible ways:

- Press and hold the programming button in the motors head 5 seconds long - Fig. 2.1a until it turns green - the drive will make a noticeable, audible one sequence of micro movements down / up;
- or turn off and turn on the ERS tubular motor twice - Fig. 2.1b - PROGRAMMING BUTTON will turn green and the drive will make a noticeable, audible single sequence of micro movements down / up;
- or restart the motor in order to recall the factory settings.

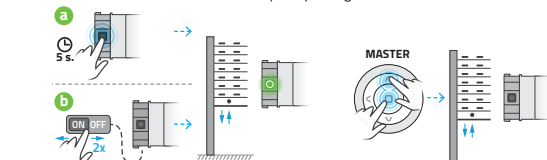

Fig. 2.1

- Press and hold the STOP and UP buttons on the transmitter for about 5 seconds. The Senso motor will register the transmitter as a MASTER, then drive up and down - the green led in the button will light up - Fig. 2.2.

TIP In order to cancel the programming procedure and return to the work mode please press the programming button on the motor twice (with the interval of max. 1 second).

- Check the direction of rotation of the ERS tubular motor. If the direction button UP is pressed on the remote control and the armor moves DOWN, the direction of rotation of the drive should be changed. To do this, simultaneously press and hold:
 - on the remote COSMO | HT, | H24, | H1, | HS, | G, | W1, | W7, | L1, | L5 buttons DOWN and UP;
 - on the remote COSMO | HCT buttons UP and F3;
 - on the remote COSMO | HM, | HB, | G3+, | W79, | WT buttons STOP and DOWN;until the drive will make a noticeable, audible one sequence of micro movements down / up. Check the operation of the UP / DOWN buttons. The change of the direction is possible only before the setting of the limit switches.
- The Senso motor works in the service - mode until the limit switches are setup. Driving up and down of the roller is possible with the UP and DOWN buttons on the transmitter.

*SERVICE MODE - lowering (raising) the blinds takes place only during pressing and holding the key DOWN (UP).

3. PROGRAMMING OF THE NEXT TRANSMITTER (CHANNEL)

- Press and hold the STOP and UP buttons for the 5 seconds on the Master transmitter. The Senso tubular motor will enter the programming mode, will make the UP/ DOWN motion, the green led in the button will light up - Fig. 3.1a.
- Press and hold the STOP and UP button on the next transmitter/channel. The Senso tubular motor will register the next transmitter/channel and will make a slow DOWN/UP motion - Fig. 3.1b.
- Adding the next transmitter/channel – please repeat the procedures from the 2. point.

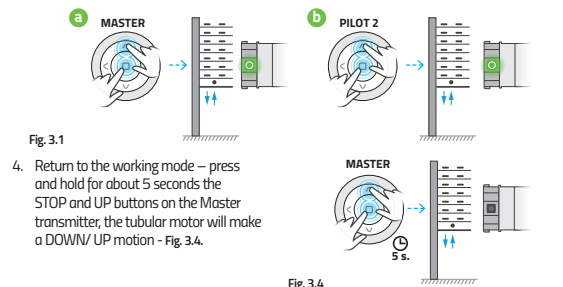

4. DELETING THE TRANSMITTERS FROM THE SENSO MOTOR'S MEMORY

- Deleting of the Master transmitter – 2 ways:
 - Reprogramming of the Master transmitter – the old Master will be replaced with the new one. The other of the transmitters will be deleted,
 - Carrying out the procedure: reset of the Senso tubular motor – recall of the factory settings.
- Delete of the other transmitters (not Master):
 - Repeating of the programming procedure of each transmitter/channel causes deleting each of them,
 - Reprogramming of the Master transmitter – the old Master will be replaced with the new one. The other transmitters will be deleted,
 - Carrying out of the procedure: reset of the Senso tubular motor – recall of the factory settings.

5. SETTING OF THE LIMIT SWITCHES

SELECTING THE LIMIT POSITION

SIGNIFICANT! Choice of the setting mode of limit switches determines the work of the Senso tubular motor: **AUTOMATIC MODE** - the Senso tubular motor detects the obstacle (set initially as a factory mode), **MANUAL MODE** - the Senso tubular motor doesn't detect any obstacles.

Enter the SETTING MODE OF THE LIMIT SWITCHES - two ways:

VARIANT 1

- Using the remote control, set the shutter at a height of approx. 40 cm above the window sill, floor, etc. - Fig. 5.1a.
- Then hold the button in the head of the tubular motor until the operator makes a visible movement of lowering / lifting the shutter - the LED in the button will flash green. The AUTOMATIC MODE is active - Fig. 5.1b.

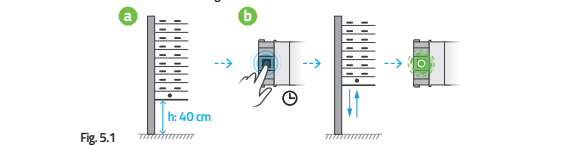

Fig. 5.1

VARIANT 2

- Using the remote control, set the shutter at a height of approx. 40 cm above the window sill, floor, etc. - Fig. 5.2a.
- On the MASTER remote control, simultaneously press and hold the STOP and UP buttons until the green LED in the head of the drive lights up (the drive will simultaneously make a noticeable, audible one sequence of micro movements down / up) - Fig. 5.2b.
- On the MASTER remote control, press and hold the DOWN button until the operator makes a visible movement of lowering / lifting the shutter - the LED in the button will flash green - Fig. 5.2c.

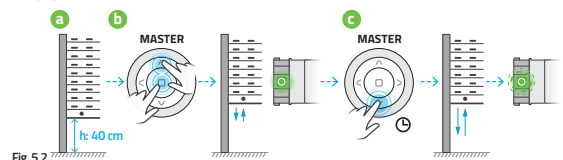
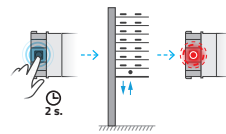

Fig. 5.2

CONTINUED 5. SETTING OF THE LIMIT SWITCHES

- If there is a need to switch the manual mode, please press and hold the programming button on the Senso tubular motor for about 2 seconds. The diode will change the colour into red.



6. SETTING OF THE LIMIT SWITCHES - AUTOMATIC MODE

AUTOMATIC MODE

SIGNIFICANT! We recommend using buffers in the endslat of the shutter. Lack of the buffers can lead to pulling the whole shutter into the roller box (e.x. during the winter when the iced shutter causes increasing of the beam diameter).

- Check if the diode in the programming but- ton blinks with the green light (automatic mode) – if not – please set the right mode - Fig. 6.1a.
- Stretch the shutter by pulling down the endslat - Fig. 6.1b.

LOWER END POSITION

- Press and hold the DOWN button for about 5 seconds on the Master transmitter – the roller will go down and stop in the low position - Fig. 6.3a.

If you would like to adjust the position of the lower end position, you can do it as follows:

a) **PRECISION SETTINGS** - working mode enabling precise positioning of the roller blind position - pressing the buttons on the remote control DOWN / UP you lower / raise the roller blind with micro movements - Fig. 6.3b.

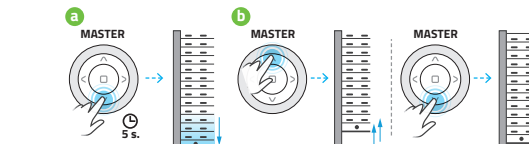

Fig. 6.3

b) **FINE SETTINGS** - precise regulation of the shutter's limit switches – press once the STOP button on the Master transmitter - Fig. 6.4a. By pressing the buttons on the remote control DOWN / UP you lower / raise the shutter with micro movements - Fig. 6.4b.

ATTENTION!!! Single re-pressing of the STOP button on the Master transmitter causes return to coarse settings.

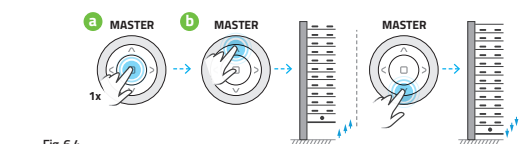

Fig. 6.4

- To confirm the selected lower end position on the MASTER remote control, press and hold the STOP button until the tubular motor makes one audible single down / up sequence. The lower end position is set - Fig. 6.5.

UPPER END POSITION

- On the MASTER remote control, press and hold the UP button (approx. 5 sec.) Until the shutter starts to lift and stops in the upper position - Fig. 6.6. If stoppers are installed (marked in red) - the ERS tubular motor will close the armor until the stoppers stop in the upper position. The tubular motor will release the armor with a gentle downward movement. If there are no stoppers, stop the armor using the STOP button on the MASTER remote control - before reaching the desired upper end position. To adjust the upper position, perform a PRECISION SETTINGS or FINE SETTINGS.

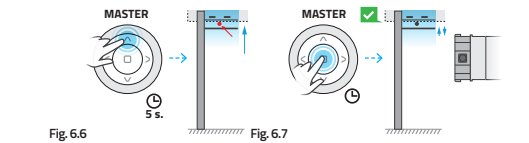

Fig. 6.6

- To confirm the selected upper limit position on the MASTER remote control, press and hold the STOP button until the tubular motor makes one audible single micro-down / up sequence at the same time. UPPER END POSITION is set. The diode will stop blinking - the tubular motor will go into WORKING MODE WITH DETECTION OF OBSTACLES - Fig. 6.7.

CONTINUED 6. SETTING OF THE LIMIT SWITCHES - AUTOMATIC MODE

ATTENTION!!! In some special cases: the large roller height compared to small pipe's beam diameter (fi 40) or too big roller's box relative to shutter's measures, there is a possibility that the roller won't reach the set up earlier limit switch because the Senso tubular motor will treat it like an obstacle (the profiles will stay slightly open). Then it's important to set up the point from which the detection will switch off manually.

SETTING THE DETECTION POINT MANUALLY:

- Press the DOWN button on the MASTER remote control - the blind will start to lower. Then the shutter will lean against the ground, the tubular motor will raise it by a part of the turn and will try to lower it again. Position the blind so that the lower shutter strip is approximately 1 cm above the ground - Fig. 6.8a.
- Press and hold the STOP and UP buttons on the Master transmitter for about 5 seconds – the Senso motor will enter the programming mode and carry out the DOWN/UP drive motions - Fig. 6.8b.
- Press and hold the UP button on the Master transmitter for about 10 seconds – the motor will register the deactivation point of the obstacle detection function and will make a DOWN/UP drive motion - Fig. 6.8c.

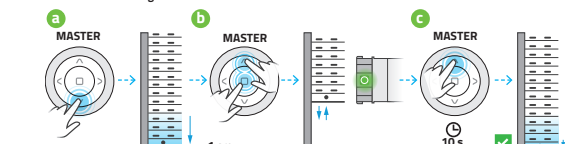

Fig. 6.8

7. THE SELF-LEARNING OPTION (ONLY WITH BUFFERS IN THE ENDSLAT)

If within 15 seconds from stopping the roller in the end position (look automatic mode 3.a., 3.b. and 4.,) you won't carry out any action from points automatic mode 3.a., 3.b. and 4., the tubular motor will automatically confirm the limit switch's end position. Then the roller will start to go up till it meets the buffer's resistance, the Senso tubular motor will start to loosen the shutter, wait 15 seconds and register the current position as an up end position. At the end the Senso tubular motor will enter the working mode with obstacle detection.

8. SETTING OF THE LIMIT SWITCHES - MANUAL MODE

MANUAL MODE.

- Check if the diode in the programming button is blinking with the red colour (manual mode) – if not – please set up the right mode - Fig. 8.1a.
- Stretch the shutter by pulling down the endslat - Fig. 8.1b.

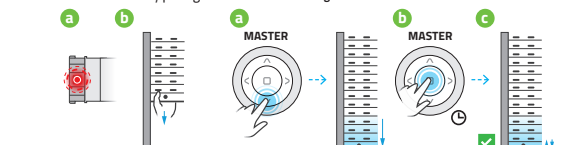

Fig. 8.1

- Press the DOWN button on the Master transmitter – the roller will start to go down. If the roller will reach the required limit switch's end position – let go the DOWN button – the roller will stop. You can correct the position of the shutter by setting up the coarse or fine settings.
- To confirm the selected lower end position on the MASTER remote control, press and hold the STOP button until the tubular motor makes one audible single micro-up / down sequence - Fig. 8.2c. LOWER END POSITION is set.

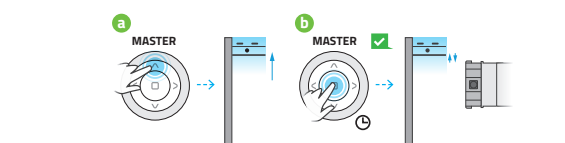
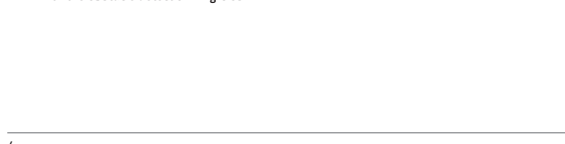

Fig. 8.2

- Press the UP button on the Master transmitter – the roller will start to go up - Fig. 8.3a.
- When the roller reaches the required up limit switch's position – please let go the UP button – the roller will stop. You can correct the position of the shutter by setting up the coarse or fine settings.
- Press twice the STOP button on the Master transmitter with interval of max 1 second – the Senso tubular motor will register the up limit switch's position and make a slow DOWN/UP motion, the blinking diode will go out, the Senso tubular motor will enter the working mode with the obstacle detection - Fig. 8.3b.



CONTINUED 8. SETTING OF THE LIMIT SWITCHES - MANUAL MODE

ATTENTION!!! The leaving of limit switch's setting mode can be carried out in 3 ways:

- Carrying out of the whole procedure of setting up the limit switches – the automatic mode/manual mode (the both limit switches confirmed),
- Finishing of the self-learning option (the both limit switches confirmed),
- Twice pressing of the programming button – with interval of max 1 second (new limit switches won't be registered).

The Senso tubular motor will confirm the leaving of limit switch's setting mode and return to the working mode with the slow DOWN/UP motion of the shutter – the blinking diode in the programming button will go out.

9. THE OBSTACLE DETECTION FUNCTION

DOWN VARIANT - user lowers the shutter by pressing the DOWN button on the transmitter. The shutter hits the obstacle. Senso tubular motor stops then lift the shutter for a part of rotation and then is trying to continue the operation of lowering the shutter. When it detects the obstacle in the same place then it will try to lift the shutter one more time and stop.

UP VARIANT - user lifts the shutter by pressing the UP button on the transmitter. If the shutter hits the obstacle, it will be blocked (e.x. by freezing the endslat). Then the Senso tubular motor stops, lower the shutter a little bit – like when it loses the shutter while automatic setting up the up and down limit switches.

10. SETTING UP THE LIMIT SWITCHES WITH THE SWITCH

- Please connect the switch according to the power supply scheme.
- Check the rotation direction of the Senso tubular motor (**ATTENTION! the correct connection: violet wire – UP orange wire – DOWN**).
- If the change of the direction is necessary please:
 - Switch on and off the Senso tubular motor's power supply twice - Fig. 10.3a. – the motor will make two short UP and DOWN moves.
 - after 2 sec. press and hold the UP button (violet wire) – the tubular motor will confirm the direction's change with the short UP/DOWN moves and diode in the tubular motor's head will go out - Fig. 10.3b.

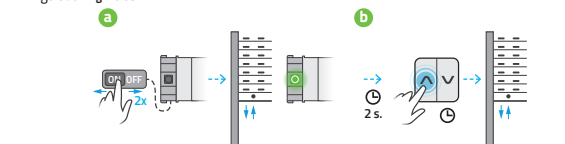

Fig. 10.3

- Using the connector, set the shutter at a height of approx. 40 cm above the window sill, floor, etc. - Fig. 10.4a.
- Switch on and off the Senso tubular motor's power supply twice (fig. 10.5) – the tubular motor will make some short UP/DOWN moves and the diode will light up with the green light - Fig. 10.4b.

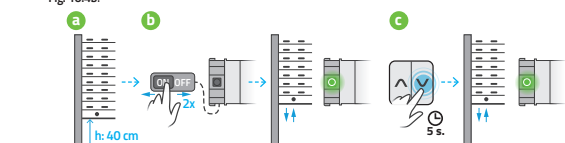

Fig. 10.4

- Press and hold the DOWN button for about 5 seconds – the tubular motor will make some DOWN/UP moves - Fig. 10.4c.
- Press and hold the DOWN button – after 5 seconds lowering the roller blind please let the button go – the tubular motor will stop near around the low limit switch (after reaching the bottom/window sill - Fig. 10.7a). Potential adjustment of the upper limit switch is possible by short pressing of the UP/DOWN buttons.

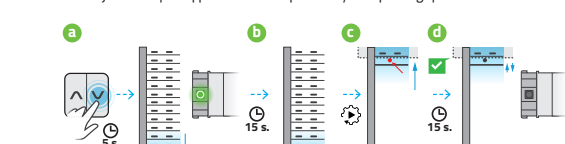

Fig. 10.5

- After 15 seconds inactivity the tubular motor will confirm the current position as a low limit switch - Fig. 10.7b and the roller blind will start to go up - Fig. 10.7c:
 - If there are any stoppers installed – the Senso tubular motor will roll up the shutter till the stopper's blockage in the up position. Then the tubular motor will stretch the shutter with the smooth DOWN motion;
 - In case of lack of the stoppers please stop the shutter before reaching the demanded UP limit switch position by pressing shortly the DOWN button. Potential adjustment of the DOWN limit switch is possible by short pressing the UP/DOWN buttons.
- After 15 seconds inactivity the tubular motor will confirm the current position as an UP limit switch and will enter the work mode (the diode in the tubular motor's head will go out). - Fig. 10.7d.