

Dexxo Optimo RTS

- EN** Installation manual
- ES** Manual de instalación
- PT** Manual de instalação
- EL** Εγχειρίδιο εγκατάστασης

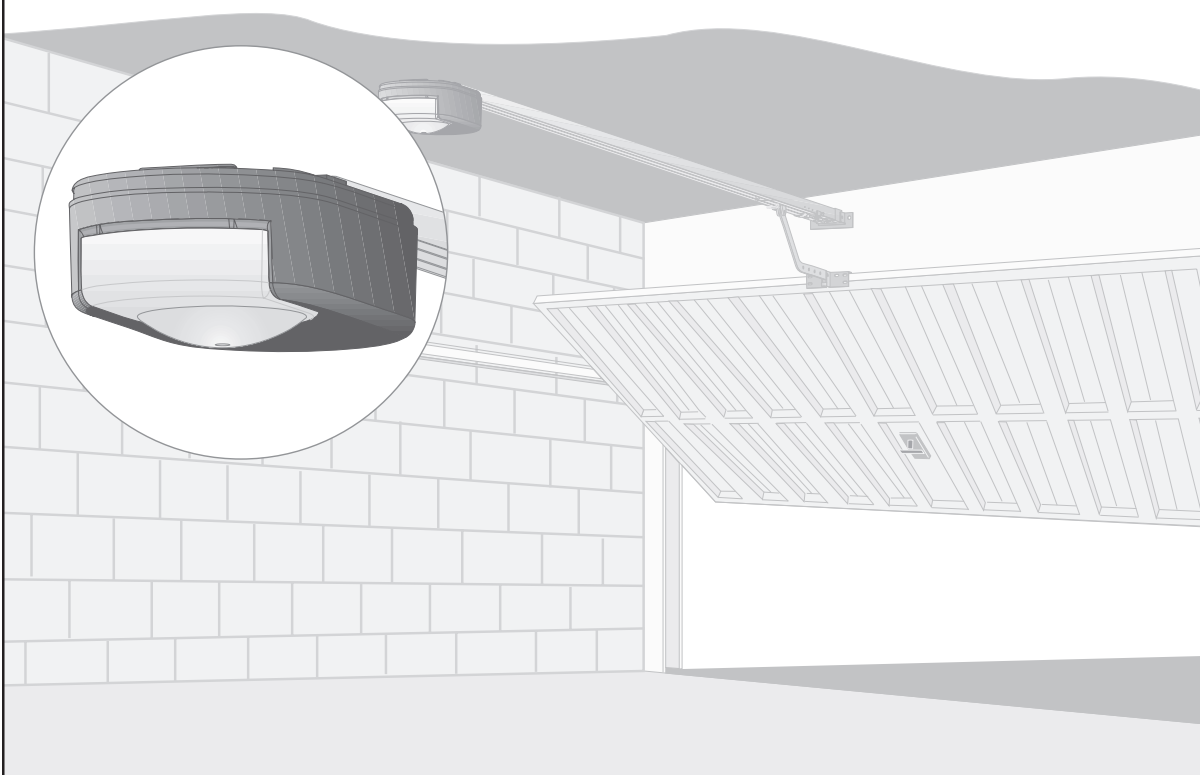

CONTENTS

EN

| | |
|---|----------|
| GENERAL PRESENTATION | 2 |
| SAFETY INSTRUCTIONS | 2 |
| Caution | 2 |
| Safety instructions | 2 |
| PRODUCT DESCRIPTION | 2 |
| Product components | 2 |
| Area of application | 2 |
| POINTS TO CHECK PRIOR TO INSTALLATION | 3 |
| Preliminary checks | 3 |
| Safety instructions | 3 |
| INSTALLATION | 3 |
| Installation height | 3 |
| Detailed description of installation steps | 3 |
| PROGRAMMING | 5 |
| Programming button description | 5 |
| End limit setting and self-learning | 5 |
| Memorising remote controls for full opening cycle | 5 |
| OPERATING TEST | 6 |
| Using the remote controls | 6 |
| Obstacle detection function | 6 |
| Built in lighting operation | 6 |
| CONNECTING PERIPHERALS | 6 |
| Description of the various peripherals | 6 |
| Electrical connections for the various peripherals | 6 |
| SETUP AND OPERATING OPTIONS | 7 |
| General setup diagram | 7 |
| Meanings of the various parameters | 7 |
| Memorising the remote control for partial opening cycle | 7 |
| Memorising the remote control for controlling lighting | 7 |
| Memorising a Telis or similar type remote control | 7 |
| SPECIAL OPERATION | 7 |
| CLEARING REMOTE CONTROLS AND ALL SETTINGS | 7 |
| Clearing remote controls | 7 |
| Resetting all settings | 7 |
| LOCKING PROGRAMMING | 7 |
| REFITTING COVERS | 7 |
| TECHNICAL SPECIFICATIONS | 8 |
| Dimensions | 8 |

GENERAL PRESENTATION

This product complies with the "safety, specific rules for powering vertically opening garage doors in residential use" requirements (standard EN 60335-2.95). When installed in line with these instructions and in compliance with the "Installation Checklist", the product will be compliant with standards EN 13241-1 and EN 12453.

The instructions referred to in the installation manual and instructions for use of this product are designed to prevent damage to property and personal injury along with compliance with the above standards. Failure to comply with these instructions absolves Somfy from any liability resulting from damage that may be caused. Dexxo Optimo RTS is a product that must be installed inside the garage with an integrated back-up control system.

Somfy hereby declares that the device is compliant with the essential demands and other relevant requirements of directive 1999/5/CE. A declaration of compliance is available from the web site at www.somfy.com/ce (Dexxo Optimo RTS).

This product is suitable for use in the European Union and in Switzerland.

SAFETY INSTRUCTIONS

Caution

These are important safety instructions. Always follow the instructions, incorrect installation may lead to serious injury.

Safety instructions

Before installing the motor drive unit, remove all unessential lines or chains and switch off all equipment that is not essential for motorised door operation.

Before installing the motor drive unit, make sure that the door is in good mechanical condition, that it is properly balanced and that it opens and closes correctly.

Locate all control systems at least 1.5 metres above floor level, making sure that they are visible from the entrance to the garage but safe from moving parts.

Position the manual release cord no more than 1.8 metres above floor level.

Where a removable release mechanism is used, we recommend storing it close to the door.

Fix the label describing the manual release procedure close to the release mechanism.

Fix the warning labels describing the hazards of door motion close to any fixed control mechanisms installed and make sure that the labels are clearly visible to the user.

After installation, make sure that the mechanism is correctly adjusted and that the motor drive unit reverses its motion when the door encounters an obstacle that is at least 50 mm from floor level.

After installation, make sure that no part of the door overhangs an area accessible to the public.

After installation, make sure that the motor drive unit inhibits or stops the door opening motion when the door is loaded down with a 20 kg weight attached to a central position of the door's bottom edge.

PRODUCT DESCRIPTION

Product components Fig. 1

| Key. | Number | Description | Key. | Number | Description |
|------|--------|-------------------------------|------|--------|------------------------------------|
| 1 | 1 | Motor head | 15 | 6 | HU8 nut |
| 2 | 1 | Motor cover | 16 | 2 | Shaft |
| 3 | 1 | Built-in light cover | 17 | 2 | Circlips |
| 4 | 1 | Lintel bracket | 19 | 4 | Self-shaping Ø 4x8 screw |
| 5 | 1 | Door bracket | 20 | 2 | Special screw for plastic Ø 3.5x12 |
| 6 | 2 | Ceiling bracket | 21a | 1 | Single part rail |
| 7 | 2 | Motor head bracket | 21b | 1 | Two part rail |
| 8 | 1 | Manual release cord | 21b1 | 1 | Sleeve |
| 9 | 1 | Link arm | 21b2 | 8 | Self-shaping Ø 4x8 screw |
| 10 | 1 | Travel stop | 22 | 2 | HM8 self-locking nut |
| 11 | 4 | Chain retainer pad | 23 | 2 | Bracket |
| 12 | 1 | Power cable | 24 | 1 | Spacer |
| 13 | 4 | Hex. head M8x16 bolt | 25 | 2 | Keytis / Keygo remote control |
| 14 | 4 | Hex. head M8x12 bolt & washer | 26 | 1 | 24 V 21 W E13 socket light bulb |

Area of application Fig. 2

Types of doors (fig.2)

A: Projecting up and over door.

B: Sectional door:

- if the door's **upper profile** is a specific one, use the "sectional door mounting bracket" ref.: 9009390.

C: Sideways opening sliding door:

- for side wall mounting, use:

- a belt transmission rail



- an "adjustable cranked arm" ref.: 9014481.

- for ceiling mounting, use:

- an "articulated arm" ref.: 9014482.

Door dimensions (Fig. 2)

For maximum door heights, the motor travel can be optimised:

- By installing the motor head at a 90° angle (Fig. 6- .
- By fixing the lintel bracket to the ceiling, behind the lintel itself by up to 200 mm (Fig. 4- .
- By cutting the link arm to size.

POINTS TO CHECK PRIOR TO INSTALLATION

Preliminary checks

Check the garage door can be operated manually and runs smoothly. Ensure the door is in good mechanical condition (pulleys, mounts...) and is correctly balanced (spring tension).



Remember that any work performed on door springs may be dangerous.

The structure of your garage (walls, lintel, inside surfaces, cross members, door rails...) are used to mount the Dexxo Optimo RTS system. Reinforce them where necessary.

Never splash water onto the system. Never install Dexxo Optimo RTS in a location where water may cause damage.

The bottom edge of the door should be fitted with a rubber strip to avoid hard contact and enhance the contact surface.

If the garage door is the only entry point into the garage, fit an external release (external release keylock (ref. 9012961) or an external release (ref. 9012962) and include a back-up battery (ref. 9001001).

If the garage door includes a separate pedestrian door, the door must be fitted with an interlock to prevent garage door movement when the pedestrian door is open (pedestrian door safety kit ref. 2400657).

If the garage door opens on to a public road, install an indicator light, such as a flashing amber light (ref. 9015171).

If the garage door operates in automatic mode, install a photoelectric cell type safety system (ref. 9014994) and a flashing amber light type indicator.

Make sure that the door does not comprise any accessible parts.



Unlocking the door may trigger uncontrolled door movement if the door is not balanced correctly.

Safety instructions

Safety instructions must be complied with throughout the installation process:

- Take off any personal jewellery (bracelet, chain or others) during installation work.
- During drilling and welding work, always wear safety glasses and suitable protection.
- Always use suitable tools.
- Take care when handling the motor drive system.
- Never connect the mains power supply or the battery back-up system before completing the installation process.
- Never use high pressure water systems for cleaning purposes.

INSTALLATION

Installation height Fig. 3

Measure the distance "D" between the door's highest point and the ceiling.

If "D" is between 35 and 200 mm, mount the complete system straight onto the ceiling.

If "D" exceeds 200 mm, mount the complete assembly so that the height "H" falls between 10 and 200 mm.

Detailed description of installation steps Fig. 4 to 14

Mounting the lintel bracket and the door bracket (Fig. 4)

When installing the system directly onto the ceiling (flush with the ceiling), the lintel bracket can be mounted on the ceiling, if necessary recessed from the lintel by up to 200 mm max. (Fig. 4- .

Assembling the two part rail (Fig. 5)

[1] [2] [3]. Unfold the two parts of the rail.

[4]. Assemble the two parts of the rail using the sleeve.

[5]. Mount the complete assembly using the eight mounting screws.

The mounting screws must not penetrate the rail (do not drill).

When installing the system directly onto the ceiling, do not use the sleeve mounting screws.

Fitting the rail onto the motor head (Fig. 6)

Fitting the complete assembly onto the garage ceiling (Fig. 7 à 9)

Fitting to the lintel bracket (Fig. 7)

Ceiling mounting

- Flush with the ceiling: mount the system directly onto the ceiling using the rail (Fig. 8).
It is possible to add mounting points at the motor head level (Fig. 8- **f**).
- Hung from the ceiling: two options:
 - mount the system at the motor head (Fig. 9- **a**).
 - mount the system at the rail (Fig. 9- **b**).
 To add an adjustable intermediate mounting along the rail, or a mounting at a dimension h between 250 mm and 550 mm, use the ceiling mounting kit ref.: 9014462 (Fig. 9- **f**).

Fitting the arm onto the door and the trolley (Fig. 10)

- [1]. Release the trolley using the manual release cord.
- [2]. Bring the trolley up to the door.
- [3]. Attach the arm to the door bracket and the trolley.

Adjusting and fastening the opening travel stop (Fig. 11)

- [1]. Release the trolley from the runner using the manual release mechanism and bring the door to the open position.
Do not open the door fully, but position it so that it does not reach its own travel stop.
- [2]. Slot the travel stop (10) into the rail then turn it by 90°.
- [3]. Position the travel stop against the trolley.
- [4]. Moderately tighten down the mounting screw.



Do not tighten the mounting screw all the way down. Excessive tightening can damage the screw and cause the travel stop not to remain in place.

Note : Do not use the travel stops supplied with the transmission rail.

Fitting the chain retainer pads (Fig. 12)

For chain rails only.

These pads are used to limit spurious noise linked to chain friction within the rail. Position each of the pads in the first hole in the rail after the travel stop. Make sure that the pad is pressed in all the way so that its positioning pin is accessible outside of the rail.

Checking the chain or belt tension (Fig. 13)

The rails are supplied ready tensioned and inspected. If necessary, adjust the tensioning.



The rubber or tension spring must never be full compressed during operation.

Connecting the mains power supply (Fig. 14)

- [1]. Remove the motor cover and the protective sheet.
- [2]. Fit the light bulb.
- [3]. Connect to the mains supply.



Plug the power cable into a suitable power outlet that complies with electric power requirements. The electric supply must be suitably protected (a fuse or circuit breaker with a 5 A rating) and a residual current device (30 mA).



An omnipolar disconnection mechanism must be provided for the power supply:
 . by using a power cord with a mains splug that can be disconnected, or
 . by fitting a switch that ensures a contact separation distance of at least 3 mm for each pole (refer to standard EN60335-1).



Make sure that the manual release cord is located at a maximum height of 1.80 metres off the ground. If necessary, extend the cord.

PROGRAMMING

Programming button description

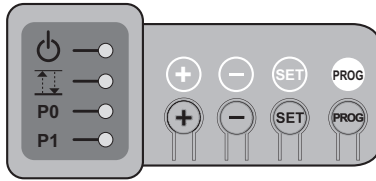

Indicator light key:

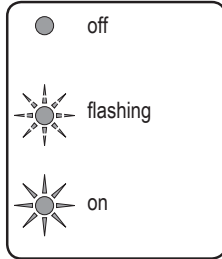

- . Press for 2 s: memorise remote controls
- . Press for 7 s: delete remote controls



- . Press for 0.5 s: call up and exit the setup menu
- . Press for 2 s: start self-learning
- . Press for 7 s: clear self-learning and settings
- . Stop self-learning



- . Modifying a setting value
- . Using the forced mode

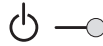

- . Operation indicator light (red)

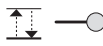

- . End limit setting and self-learning indicator light (green)

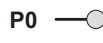

- . P0 - P1 parameters indicator (green)

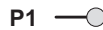

End limit setting and self-learning **Fig. 15**

[1]. Press the "SET" button until the light comes on (2 s).

- The indicator light flashes.

[2]. Control the motor using the "+" or "-" buttons so that the transmission system runner moves to link up with the trolley and closes the door.

- Pressing and holding the "-" button moves the runner in the **close** direction.
Release the "-" button before the motor has time to force against the door.
- Pressing and holding the "+" button moves the runner in the **open** direction.

[3]. Adjust the closed position using the "+" or "-" buttons.

- **Release the "-" button before the motor has time to force against the door.**

[4]. Press "SET" to validate the closed end limit and start the self-learning cycle.

The door runs through a complete Open Close cycle and the indicator light goes out.

- If the self-learning cycle was completed correctly, the indicator light stays on.
- If the self-learning cycle was not completed correctly, the indicator light continues to flash.

During self-learning:

- When the door is moving, pressing any button will stop the movement and stop the self-learning mode.
- When the door is stopped, pressing "SET" until the light comes on and the indicator light comes off (2 s) will exit the self-learning mode.

The self-learning mode can be called up at any time even after the self-learning cycle has been completed.

Memorising remote controls for full opening cycle **Fig. 16**

Up to 32 control channels can be stored.

Running this procedure for a previously stored channel will clear it.

At this stage in the installation process, the Dexxo Optimo RTS motor drive unit is ready to run.

OPERATING TEST

Using the remote controls **Fig. 17**

Obstacle detection function **Fig. 18 and 19**

The detection of an obstacle during door opening will stop the door (**Fig. 18**).

The detection of an obstacle during door closure will reopen the door (**Fig. 19**).

Make sure that obstacle detection works when the door encounters an obstacle 50 mm from the ground.

Built in lighting operation

The light will come on every time the motor drive unit is operated. It will go out automatically after one minute once the door stops. Repetitive use which causes the light to stay on continually may result in an automatic cut-off condition triggered by the thermal cut out protection mechanism.

CONNECTING PERIPHERALS

Description of the various peripherals **Fig. 20**

| Key | Description |
|-----|----------------------------|
| 1 | Amber light |
| 3 | Code keypad |
| 4 | Keyswitch |
| 5 | Aerial |
| 6 | Battery |
| 7 | Pedestrian door safety kit |
| 8 | Photoelectric cells |

Electrical connections for the various peripherals **Fig. 20 to 22**

Cut the electric power supply to the motor before performing any work on peripherals. The  indicator light remains off after working on the system, check the wiring (for possible short circuits or polarity reversals).

General electrical diagram (Fig. 20)

Pedestrian door safety kit

When the pedestrian door contact is fitted, it must be connected in place of the jumper normally fitted between terminals 3 and 4.



If the pedestrian door contact is removed, the jumper between terminals 3 and 4 must be refitted.

Photoelectric cells (Fig. 21)

When fitting photoelectric cells, connect the receiver cell (RX) to the input in place of the jumper fitted between terminals 5 and 6.



If the cells are removed, the jumper between terminals 5 and 6 must be refitted.







Code keypad (Fig. 22)

SETUP AND OPERATING OPTIONS

General setup diagram **Fig. 23**

Meanings of the various parameters

Programming example: adjusting the long slowdown zone "P1=3" (Fig. 24)

| Code | Description | Values | Comments |
|------|--------------------------------|---|--|
| P0 | Obstacle detection sensitivity | 1 -  : low sensitivity 2 -  : low sensitivity 3 -  : standard 4 -  : high sensitivity | If this setting is changed, it is essential to run the force measurement sequence at the end of the installation procedure |
| P1 | Closure approach speed | 1 -  : no slowdown 2 -  : short soft stop 3 -  : long soft stop | P1=1: no slowdown before closure. P1=2: speed is reduced during the last 20 centimetres. P1=3: speed is reduced during the last 50 centimetres. If this setting is changed, it is essential to run the force measurement sequence at the end of the installation procedure. |

Memorising the remote control for partial opening cycle **Fig. 25**

Memorising the remote control for controlling lighting **Fig. 26**

Memorising a Telis or similar type remote control **Fig. 27**

SPECIAL OPERATION

Refer to the User's Manual.

CLEARING REMOTE CONTROLS AND ALL SETTINGS

Clearing remote controls **Fig. 28**

Press the "PROG" button until the light blinks (7 s).

This clears all of the remote controls memorised.

Resetting all settings **Fig. 29**

Press the "SET" button until the light goes out (7 s).

This clears all previously stored settings and returns them to their default values.

LOCKING PROGRAMMING (Fig. 30)

Used to lock the programming settings (end limit setting, self-learning, setup).

Simultaneously press the "SET", "+" and "-" buttons:

- start by pressing "SET".
- pressing "+" and "-" must take place within two seconds.

Pressing the "SET" button then no longer has any effect.

The remote control memorising functions ("PROG" button) and forced mode operation ("+", "-" buttons) remain possible.

To access programming mode once again, repeat the same procedure.

REFITTING COVERS (Fig. 31)

Position the aerial and fit the covers.



To ensure proper remote control range, the aerial must be fitted in one of the two positions shown in Figure 31.

TECHNICAL SPECIFICATIONS

Dexxo Optimo RTS

BASIC TECHNICAL CHARACTERISTICS

| | | |
|--|--------------------|--|
| Mains power supply | | 230 V - 50 Hz |
| Max. power consumption | Standby-Operation | 4 W - 120 W |
| Traction force | Peak force | 800 N |
| | Starting force (1) | 650 N |
| Use | | 20 cycles per day max. tested for 36,500 cycles |
| Number of Opening/Closing cycles per day | | |
| Max. speed | | 14 cm/s |
| Programming interface | | 4 buttons - 4 indicator lights |
| Operating temperature | | - 20 °C/ + 60 °C- indoor dry - IP 20 |
| Travel end limits | | Mechanical stopper at opening |
| | | Memorized end limit position at closing |
| Electrical insulation | | Class 2: double insulation  |
| Built in lighting | | 24 V / 21 W; E13 socket |
| Somfy radio frequency | | RTS 433,42 MHz |
| Number of channels that can be memorised | | 32 |

CONNECTIONS

| | | |
|-------------------------------|---------------|--|
| Safety input | Type | Dry contact: NC |
| | Compatibility | Photoelectric TX/RX cells |
| Pedestrian door safety input | | Dry contact: NC |
| Wired control input | | Dry contact: NO |
| Amber light output | | 24 V - 15 W with built in flashing control |
| Accessory power supply output | | 24 V - 500 mA max |
| Remote aerial input | | Yes: RTS aerial compatible (Réf. 2400472) |
| Backup battery input | Autonomy | Yes: battery pack compatible (Réf. 9001001) 24 hours; 5 to 10 cycles depending on door Charge time: 48 hours |

OPERATION

| | | |
|--------------------------------------|--|---|
| Forced operation mode | | By pressing and holding the motor control button |
| Independent lighting control | | Yes for built-in lighting |
| Lighting time delay (after movement) | | Fixed 60 s |
| Amber light pre-warning | | 2 s automatic if light connected |
| Safety input operation | While closing | Fully reopens |
| | Before opening | None |
| | (Dangerous Movement Area Accessible to the Public) | |
| Built-in obstacle detection | | Adjustable sensitivity: 4 levels |
| Operation after obstacle detection | | Full re-opening |
| Progressive start up | | Yes |
| Opening speed | | Set: 14 cm/s (max.) |
| Closing speed | | Set: 12 cm/s (max.) |
| Closure approach speed | | Programmable: does not slow down, short slowdown zone (30 cm), long slowdown zone (50 cm) |

(1) Maximum load for motor to start and drive door for at least 5 cm (according to RAL-GZ definition).

Dimensions

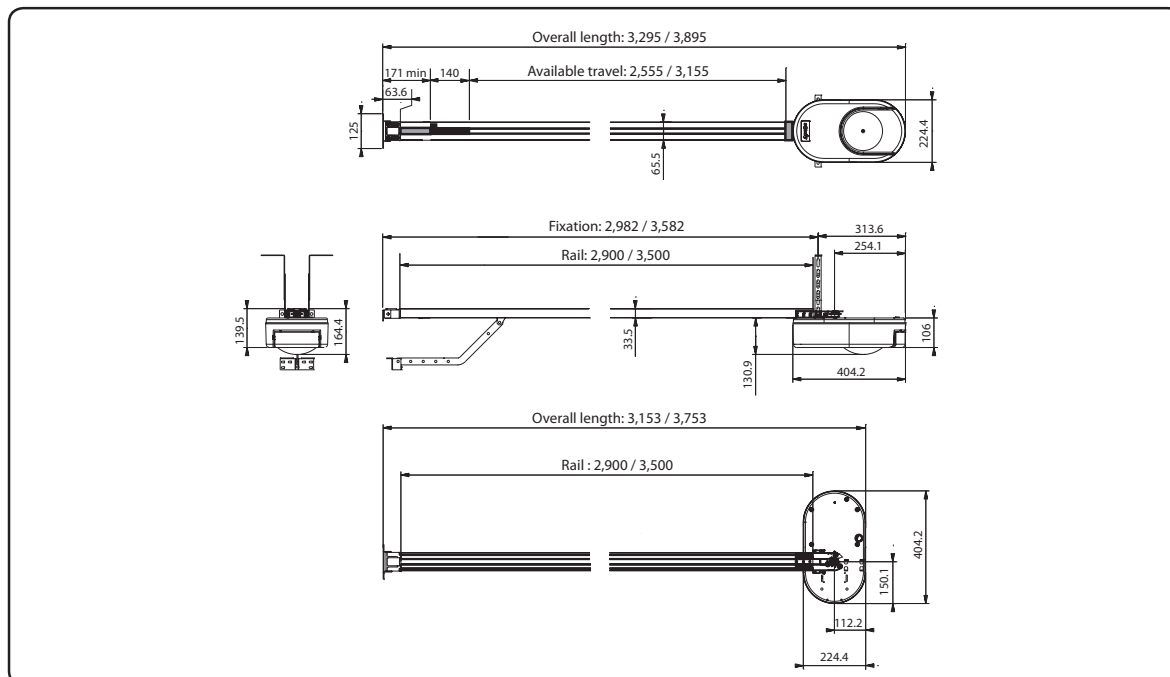

Dexxo Optimo RTS User Manual

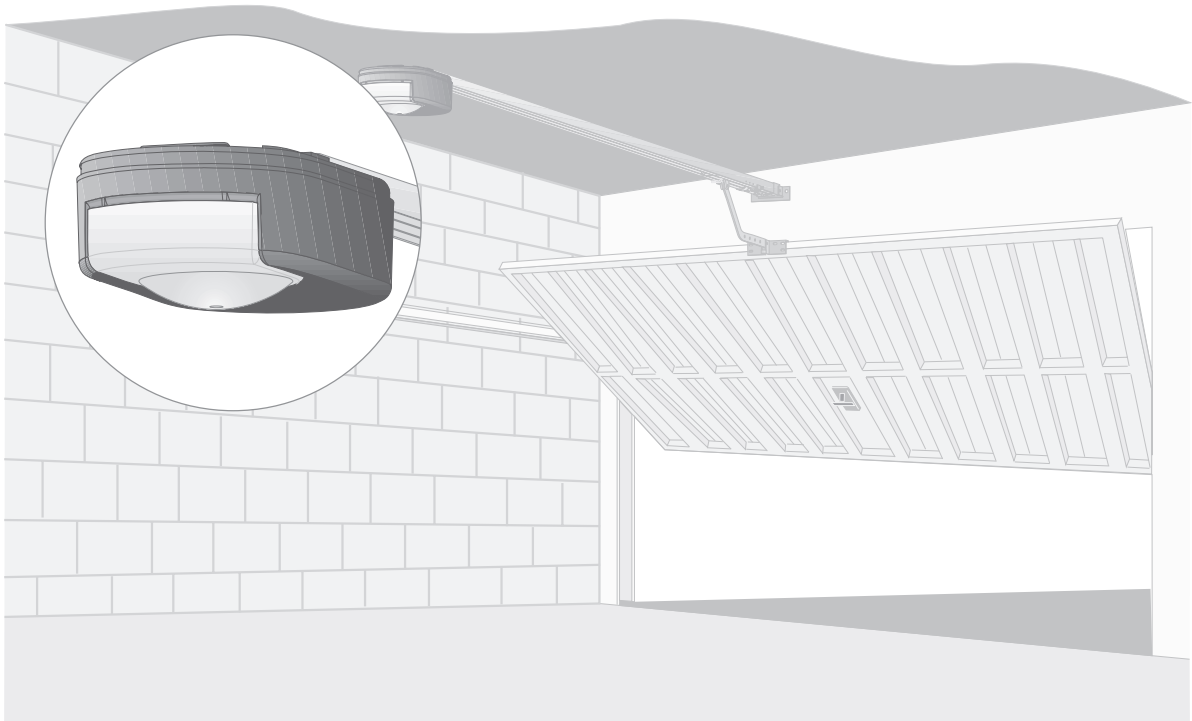

CONTENTS

| | |
|--------------------------------------|----------|
| GENERAL PRESENTATION | 2 |
| The world of Somfy | 2 |
| Support | 2 |
| SAFETY INSTRUCTIONS | 2 |
| Standards | 2 |
| Safety instructions | 2 |
| PRODUCT PRESENTATION | 2 |
| OPERATION AND USE | 3 |
| Normal operation | 3 |
| Special operation | 4 |
| PERIPHERALS | 5 |
| MAINTENANCE | 5 |
| Replacing the bulb in the light unit | 5 |
| Checking | 6 |
| Battery replacement | 6 |
| TECHNICAL SPECIFICATIONS | 6 |



GENERAL PRESENTATION

Thank you for choosing a Somfy product. This product is designed and manufactured by Somfy in line with quality procedures that are ISO 9001 compliant.

The world of Somfy

Somfy develops, produces and sells automation systems for residential and commercial applications. Alarm systems, automatic blinds and shutters, garage doors and gates - all Somfy products are designed to fulfill your needs in terms of safety, comfort and security.

At Somfy, the quest for quality is a continual process. Somfy has built its reputation on the quality of its products and is synonymous with innovation and technological leadership worldwide.

Support

Getting to know you, listening, answering your needs, is all part of the Somfy approach.

Please contact your local Somfy retailer or installer for details on other Somfy products.

Internet: www.somfy.com

© SOMFY. SOMFY SAS, capital 20.000.000 Euros, RCS Bonneville 303.970.230

SAFETY INSTRUCTIONS

Standards

This product complies with the "safety, specific rules for powering vertically opening garage doors in residential use" requirements (standard EN 60335-2.95). When installed in line with these instructions and in compliance with the "Installation Checklist", the product will be compliant with standards EN 13241-1 and EN 12453.

The instructions referred to in the Installation Manual and Instructions for Use of this product are designed to ensure that damage to property and injury to persons is avoided along with compliance with the above standards. Failure to comply with these instructions absolves Somfy from any liability for any damage that may be caused. Dexxo Optimo RTS is a product that must be installed inside the garage with a built-in back-up control system.

Somfy hereby declares that the device is compliant with the essential demands and other relevant requirements of directive 1999/5/CE. A declaration of compliance is available from the web site at www.somfy.com/ce (Dexxo Optimo RTS).

This product is usable in the European Union and in Switzerland.



These are important safety instructions. For safety reasons, it is important to always follow all instructions. Retain these instructions for future reference.

Safety instructions

Every month, test that the motor drive unit reverses its motion when it encounters an obstacle that is at least 50 mm from ground level. If this is not the case, call your installation specialist. Always be very careful when using the manual release cord for a manually operated door may fall quickly due to weak or broken springs or if it is badly balanced.

Before manually operating the door or performing maintenance work, always turn the power off and where necessary remove the battery (Fig. 1).

Never let children play with door control systems. Keep the remote controls out of reach of children (Fig. 2).

When replacing the light bulb, select a 24 V 21 W E13 type (Fig. 3).

Regularly check the operation of the door to identify any sign of wear, deterioration or incorrect balancing. Do not operate the door if repairs or adjustments are required.

Remain at a safe distance when operating the door.

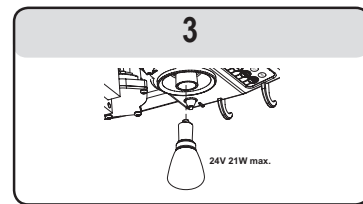
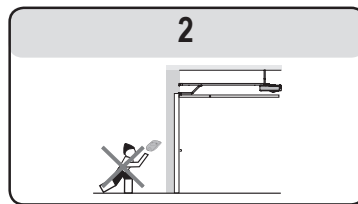
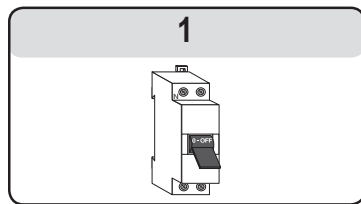

PRODUCT PRESENTATION

Description (Fig. 4)

The Dexxo Optimo RTS system is designed to power garage doors in residential use.

This motor drive system comprises:

- A motor head (1) with integrated light (2).
- A rail assembly (3) with a manual release cord (4).

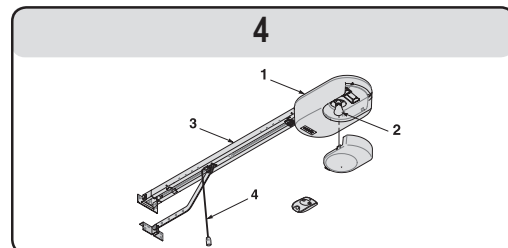

OPERATION AND USE

Normal operation

Full opening cycle using Keytis or similar remote controls (Fig. 5a)

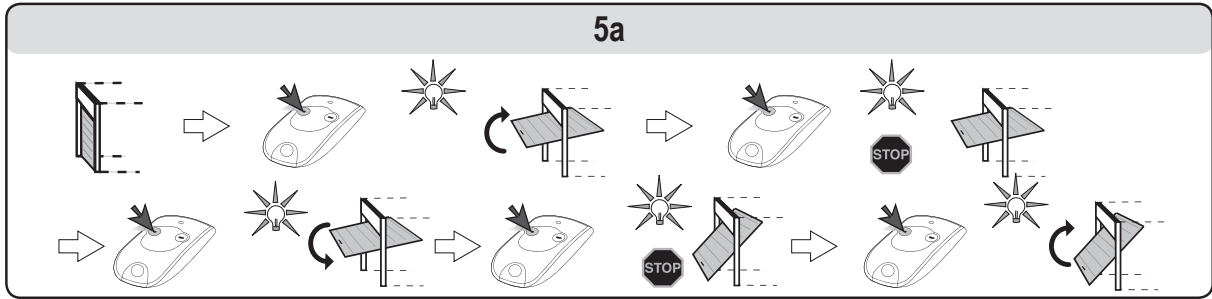

Partial opening cycle using Keytis or similar remote controls (Fig. 5b)

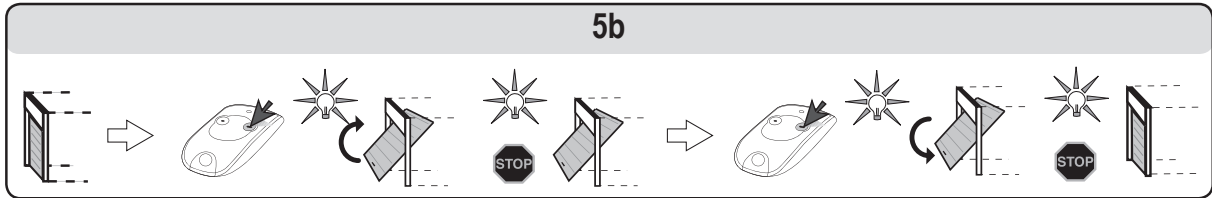

Obstacle detection operation (Fig. 6 and 7)

When an obstacle is detected during the open cycle, the door will stop (Fig. 6).

When an obstacle is detected during the close cycle, the door will stop and then reopen (Fig. 7).

Once an obstacle has been detected, the light will flash for 30 seconds.

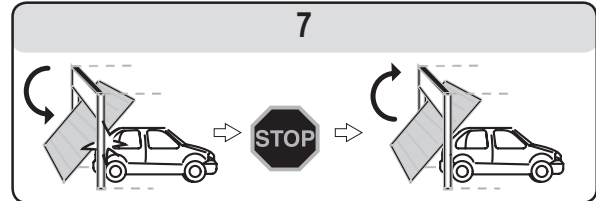
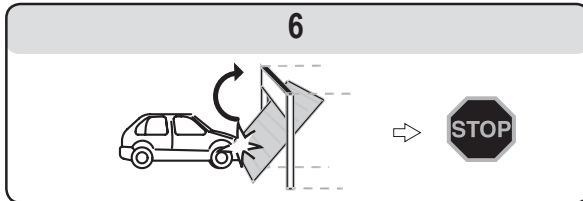

Light operation

The light will come on each time the motor drive unit is operated. The light will go out one minute after the door stops moving. Repetitive use that causes the light to be continually on may result in a thermal cut out (this will automatically turn the light off).

Manual release cord operation (Fig. 8)

Dexxo Optimo RTS is fitted with a manual release mechanism so that you can move the door manually should a power failure occur, for example. The manual release mechanism should be easily accessible and located **no more than 1.80 metres** above floor level.

- [1]. Disengaging the motor drive mechanism
Pull on the manual release cord until the door drive mechanism is disengaged.
- [2]. Manually moving the door
This is possible as long as the door mechanism is disengaged.
- [3]. Reengaging the motor drive mechanism
Move the door manually until the drive mechanism comes to reengage itself into the transmission rail.

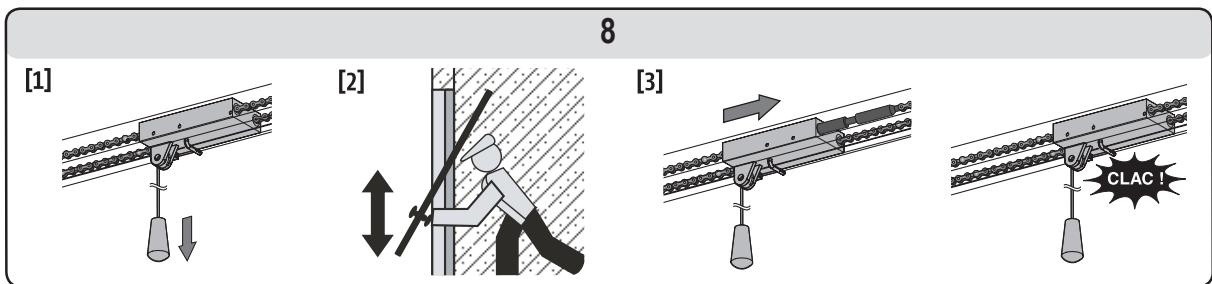

When disengaging the motor drive mechanism, use caution for a badly balanced door may cause sudden door movement that may be dangerous.

Only use the cord to disengage the motor drive mechanism. Never use the cord to move the door manually. Always reengage the motor drive mechanism before sending another command to the motor drive unit.

Special operation

Depending on the peripherals installed and the operating options set by your installer, the Dexxo Optimo RTS system may perform the following special operations:

Full opening cycle using Telis or similar remote controls (Fig. 9a)

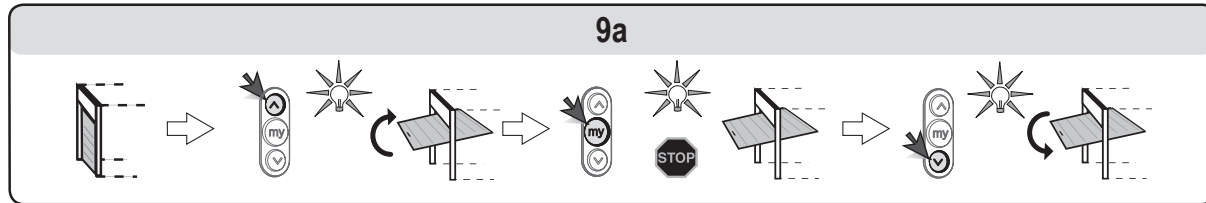

Partial opening cycle using Telis or similar remote controls (Fig. 9b)

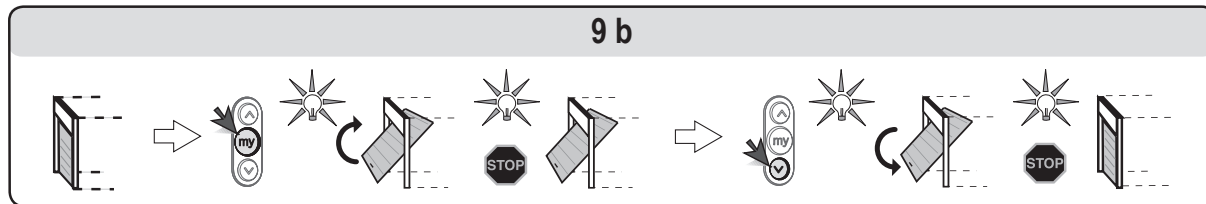

Safety photoelectric cell operation

An obstacle detected between the cells will prevent the door from closing.

The door will stop and then reopen when an obstacle is detected during the close cycle.

The light will flash for 30 seconds during this process.

Pedestrian door safety function

Opening a pedestrian door within the garage door will prevent the door from moving.

The light will flash for 30 seconds during this process.

Flashing amber light

The amber light comes on whenever the door moves, with a two second advance warning before the start of door motion.

Working from the back-up battery

If a back-up battery is installed, the Dexxo Optimo RTS motor will operate when a power cut occurs.

The following conditions apply to operation:

- Door speed is reduced.
- The light will not come on.
- The safety devices are disabled.

Battery specifications:

- Endurance: the battery will last for 24 hours with a maximum of 5 to 10 operating cycles depending on the weight of the door.
- Recharging time: 48 hours.
- Service life prior to replacement: approx. three years.

To ensure optimum battery life, we recommend that the power to the motor is switched off and the door is operated for a number of cycles using battery power (three times a year).

Forced operation mode (Fig. 10)

This function is used to move the door at any time (remote control lost, safety mechanism failure, etc.).

Remove the built-in lighting cover:

- Control door motion using the "+" and "-" buttons.
- Pressing and holding the "-" button will trigger closure.
- Pressing and holding the "+" button will trigger opening.

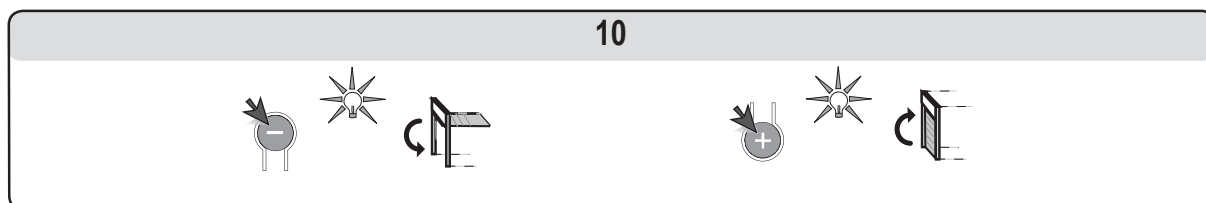

PERIPHERALS

A number of peripherals are available.

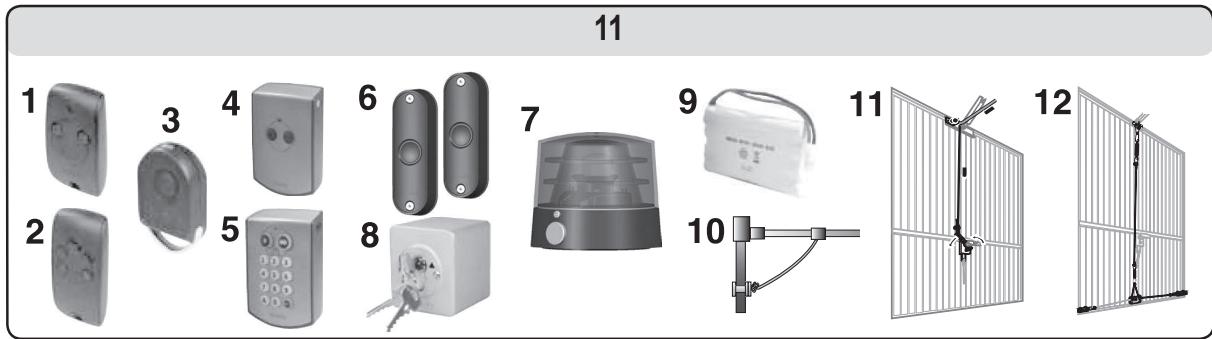

| Key | Description | Comments |
|-----|-------------------------------|--|
| 1 | Keytis 2NS RTS remote control | Hand held 2 channel remote control. |
| 2 | Keytis 4NS RTS remote control | Hand held 4 channel remote control. |
| 3 | KEYGO remote control | Four channel keyring remote control. |
| 4 | RTS pushbutton | Wall mounted 2 channel remote control switch. |
| 5 | RTS radio code keypad | Access code control point. For use outside the garage. |
| 6 | Photoelectric cells | To prevent door closure if an obstacle is detected. |
| 7 | Amber light | To signal a warning when the door operates. |
| 8 | Keyswitch | Keyswitch for secure control. |
| 9 | Battery | To provide continued operation during a power cut. |
| 10 | Release lock | To engage the manual release system from the outside using the existing door handle. Highly recommended when the garage door is the only access point into the garage. |
| 11 | Outside release lock | To engage the manual release system from the outside using the existing door handle. Highly recommended when the garage door is the only access point into the garage. |
| 12 | Door locking kit | A system to reinforce door locking. |

MAINTENANCE

Replacing the bulb in the light unit (Fig. 12)

[1] [2]. Remove the light cover.

[3] [4]. Unscrew and replace the defective light bulb.

[5] [6] [7]. Refit the light cover.

Use a 24 V 21 W E13 socket light bulb.

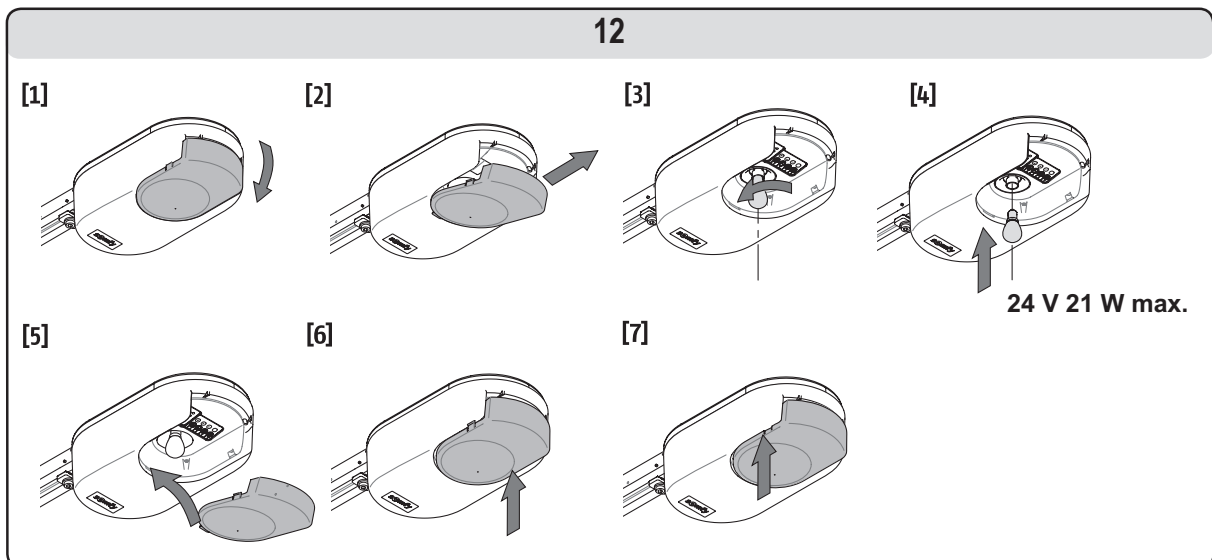

Checking

The obstacle detection function

Every six months, check that the door reverses direction when an obstacle prevents the door from closing (at least 50 mm above floor level).

The safety mechanisms (cells, pedestrian door contact)

Check correct operation every six months (refer to page 4).

The back-up battery

To ensure optimum battery life, we recommend that the power to the motor is switched off and the door is operated for a number of cycles using battery power (three times a year).

Battery replacement

Keytis

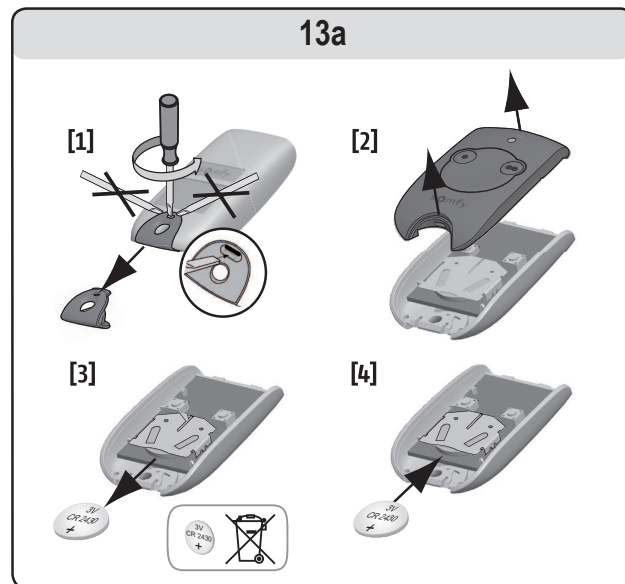

Keygo

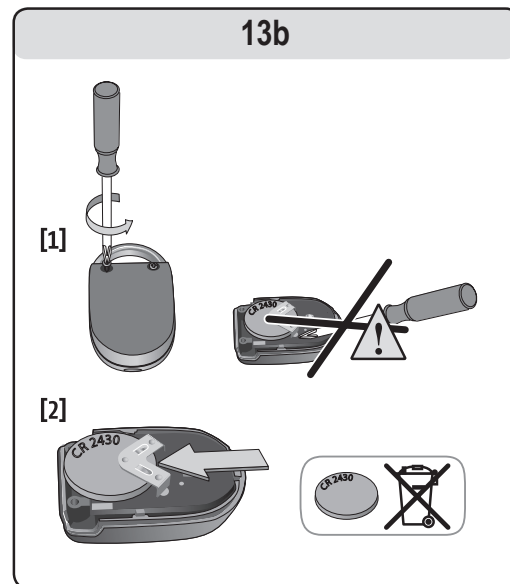

RECYCLING



Do not dispose of your scrapped appliances, nor your used batteries with household waste. You are liable to dispose of all your electronic or electrical equipment waste by relocating over to a dedicated collection point for recycling.

TECHNICAL SPECIFICATIONS

| Basic technical specifications | |
|--|---|
| Mains power supply | 230 V - 50 Hz |
| Power consumption on standby | 4 W |
| Max. power consumption | 120 W |
| Traction force – Peak force | 800 N |
| Use | 20 cycles per day with a standard rail (tested for 36,500 cycles) |
| Number of channels that can be memorised | 32 |
| Somfy radio frequency | 433,42 MHz RTS |
| Integrated light | 24 V / 21 W max. E13 socket |
| Operating temperature | -20 °C / +60 °C |